



SS88HPR

SAFARI ARMAX SNORKEL

Toyota Land Cruiser 200 Series (Pre-Face Lift)
 1VD-FTV 4.5Litre-V8 Intercooled Twin Turbo Diesel
 Replaces Factory Toyota Raised Air Intake
 Build dates: 2008 – 10/2015



01/10/2017

Parts List

ITEM	PART NO.	DESCRIPTION	QTY
1	370-133-200	BODY - SNORKEL (SS88HP)	1
2	000-135-960	4" AIR RAM ASSEMBLY	1
3	370-032-200	BRACKET - UPPER MOUNTING	1
4	000-002-100	BOLT - HEX - 6mm x 1.0 x 14mm (SEMS)	2
5	000-951	SCREW - S/T - 4.2mm x 13mm - S/S	3
6	000-960	INSERT - PLASTIC	3
7	000-110	STUD - 8mm x 1.25 x 25mm - S/S	6
8	000-377	WASHER - RUBBER - 8.5 x 42 x 3mm	6
9	000-349-300	WASHER - BODY - 8.4mm x 40mm - S/S	6
10	000-205-300	NUT - NYLOC - 8mm x 1.25mm - S/S	6
11	370-024-200	HOSE - AIR ENTRY	1
12	000-910	CLAMP - HOSE - 90/110mm - S/S	1
13	000-1913	CLAMP - HOSE - 120/140mm - S/S	1
14	370-967-200	PANEL - GUARD INFILL - S/S	1
15	000-958-525	POP RIVET - 4.8mm x 10mm	4
16	370-025-600	SLEEVE - AIR INLET SUPPORT - 94.5mm x 35mm - Zinc Plated	1

17	370-704-000	PLATE - BLANK-OFF (A-PILLAR)	1
18	370-435-200	RUBBER GASKET	1
19	000-1931/B	CLAMP - HOSE - SIZE 64 (BLACK)	1
20	370-016-200	GASKET - FOAM BODY (SELF ADHESIVE)	1
21	370-017-200	TEMPLATE - GUARD PANEL	1
22	370-017-300	TEMPLATE - GUARD PANEL INFILL	1



SS88HPR

SAFARI ARMAX SNORKEL

Toyota Land Cruiser 200 Series (Pre-Face Lift)
 1VD-FTV 4.5Litre-V8 Intercooled Twin Turbo Diesel
 Replaces Factory Toyota Raised Air Intake
 Build dates: 2008 – 10/2015

Installation Guide

Fitment to:

- Right Hand Side

Fitting Time:

- 210min

Special Tools:

- 114mm Holesaw
- Body saw (reciprocating)
- Step drill
- 5.5mm & 6.5mm Drill Bits
- Die Grinder
- Pop Rivet Gun
- Files
- Loctite 243 (thread lock)
- Sikaflex 227 Adhesive Sealant
- Touch-up paint
- Prep-wash
- Masking tape

Prior to commencing the installation, it is the installer's responsibility to verify that all components and particularly the templates (Item's 21 & 22) are correct.

1

Remove the RHS mud flap, inner guard liner, guard mounted indicator (it fitted to vehicle) and the air cleaner assembly in accordance with the factory service manual.

2

Remove and discard the Factory Toyota Raise Air Intake components (shown).

The following hardware must be retained, two A-pillar bracket mounting bolt assemblies as shown.



The front factory captive mounting nut assembly must be removed.

The assembly is spot welded to the guard panel in two places.

Drill a pilot hole in the centre of each spot weld, drill out the spot welds using a 6.5mm drill bit or spot weld drill bit.

Use a small pry bar or flat blade screwdriver to break the spot welds from the guard panel, remove and discard the mounting nut assembly.

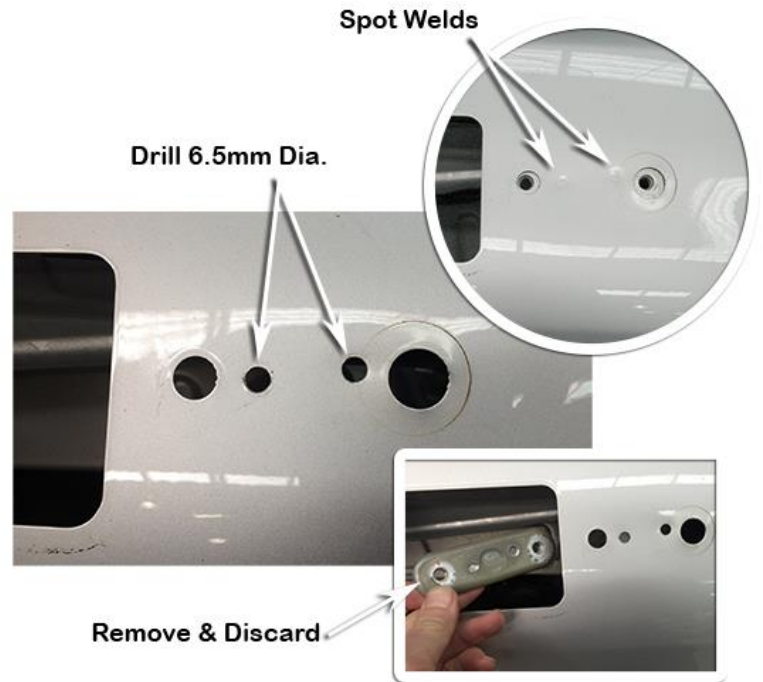

Align the guard panel infill template (item 22) to the three standard holes in the right hand guard panel as shown.

Tape the template to the guard panel with masking tape.

Mark the four hole positions and the snorkel body mounting hole position with a felt tip pen.

Remove the template.

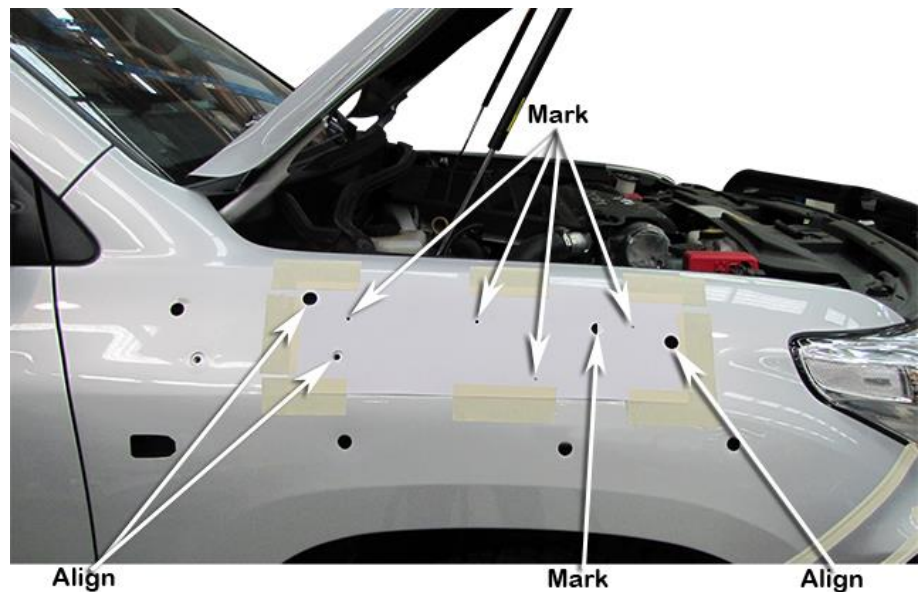

Drill a pilot hole for each of the marked hole positions, drill the four hole positions to 5.5mm diameter using a 5.5mm drill bit.

Using a round file, file the snorkel body mounting hole position as marked in step 4.

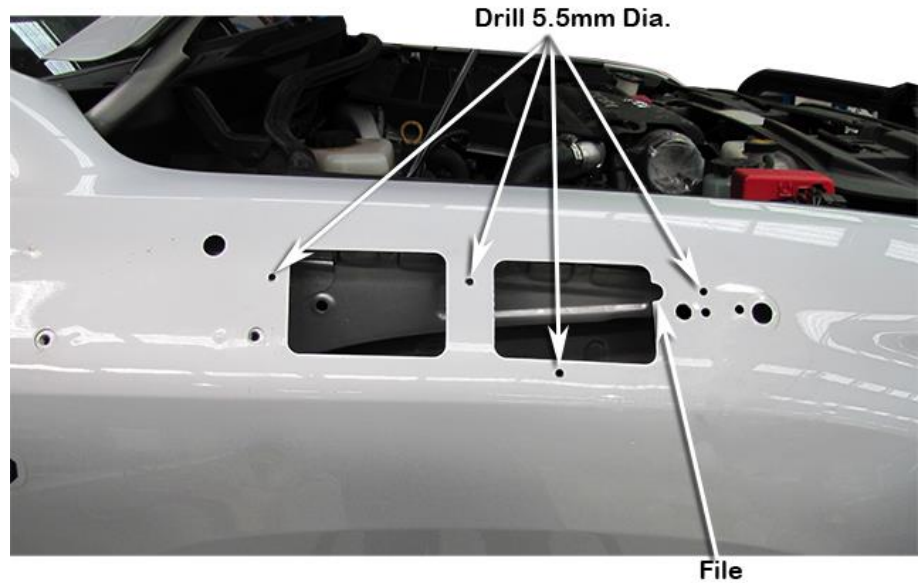

Remove and discard the perforated section of the guard panel template (item 21) as shown.

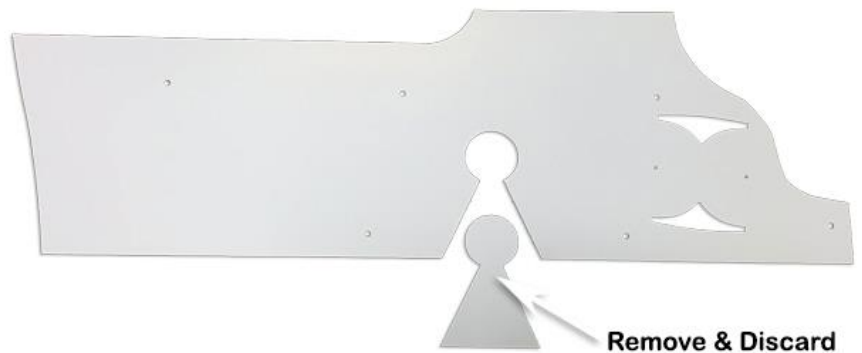

Align the guard panel template (Item 21) to the upper and rear edges of the right hand guard panel as shown.

Tape the template to the guard with masking tape.

Mark the four mounting hole positions, holesaw centres and the guard panel cut out sections with a felt tip pen as shown.

Remove the template.

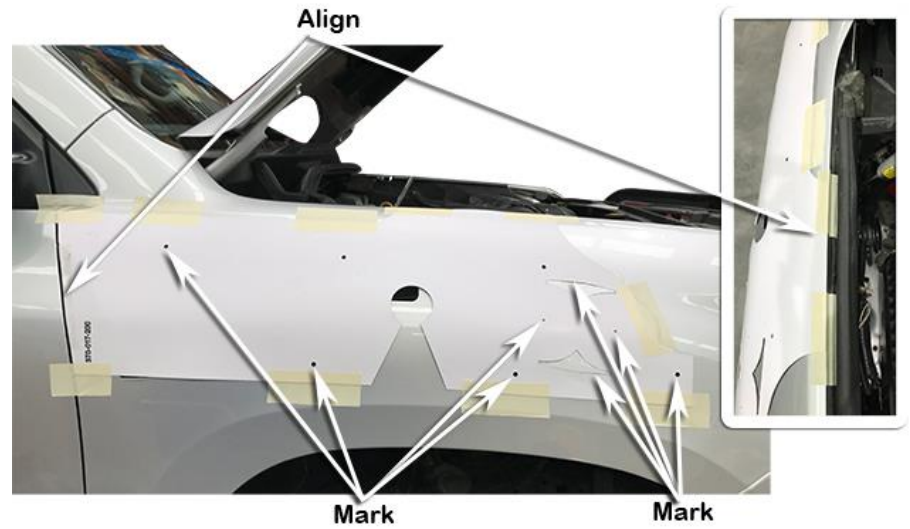

Drill a pilot hole for each of the marked positions.

Use a step drill to drill the 4 mounting holes to 16mm diameter.

Use a 114mm diameter hole saw to drill the snorkel body outlet snout hole positions.

Use a body saw to trim away the upper and lower sections of the guard panel between the two 114mm diameter holes as per the template cut outs.

Deburr and paint all holes and cut sections of guard panel.

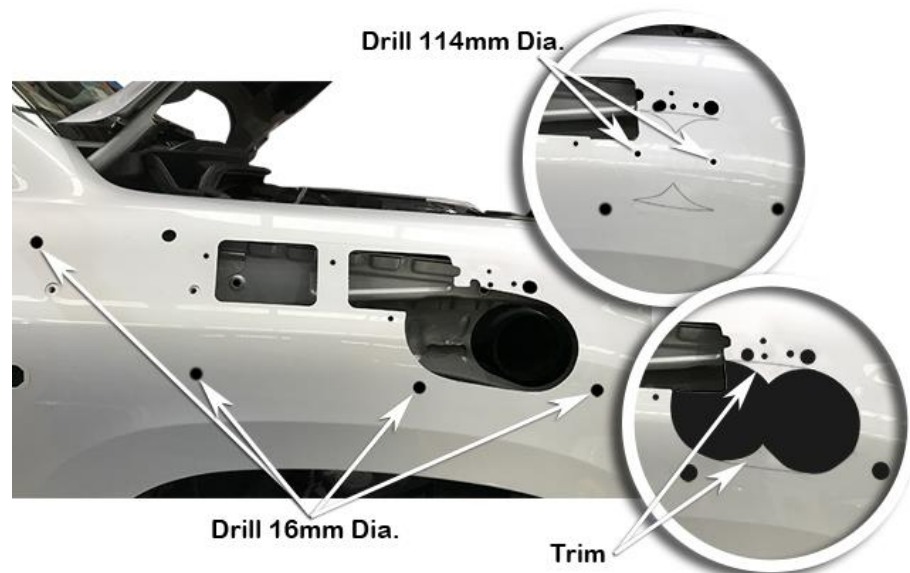

Trial fit the guard infill panel (item 14), loosely install all four pop rivets (item 15) to the guard panel.

Using a felt tip pen, mark the two standard rectangular guard panel holes onto the infill panel.

Remove the pop rivets and infill panel.

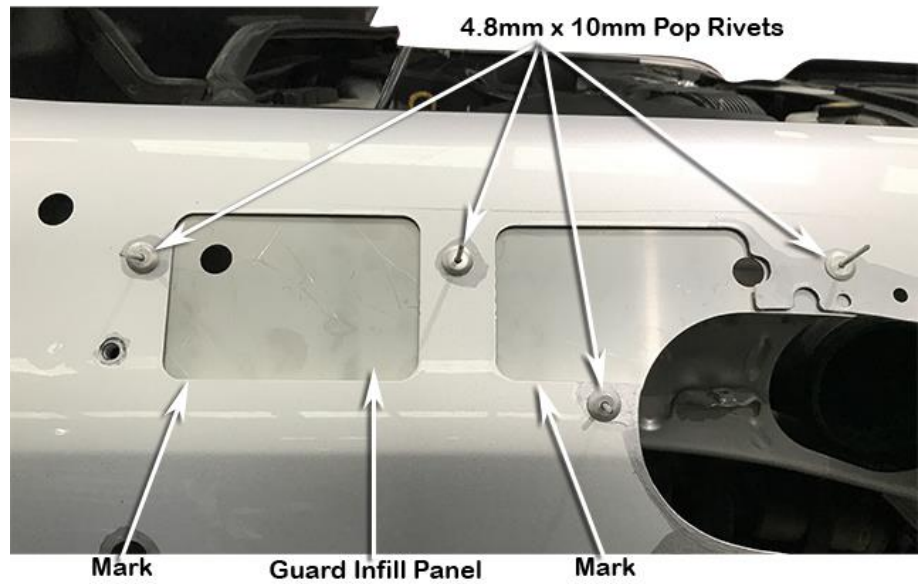

Apply Sikaflex 227 to the outer edges and centre of the guard infill panel (item 14) as shown, install the infill panel to the guard panel, install all 4 pop rivets (item 15).

With the infill panel and all four pop rivets correctly installed, secure the pop rivets using the pop rivet gun.

Clean up any excess sealant to ensure a neat finish.

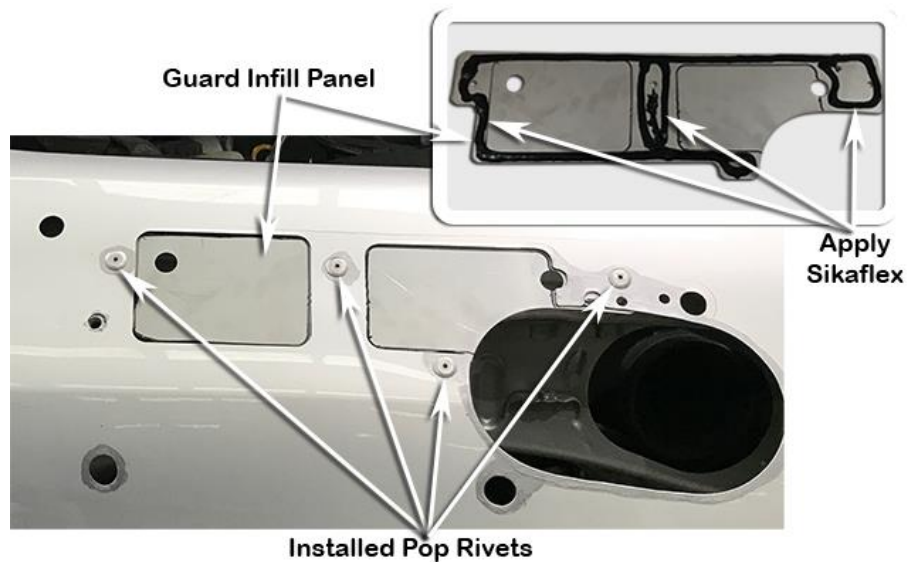

11

Install the upper mounting bracket (Item 3) to the snorkel body (Item 1) with hex bolts (Item 4).

Apply Loctite 243 to each of the stainless steel mounting studs (Item 7) and install the studs finger tight into the snorkel body (item 1) mounting inserts as shown.

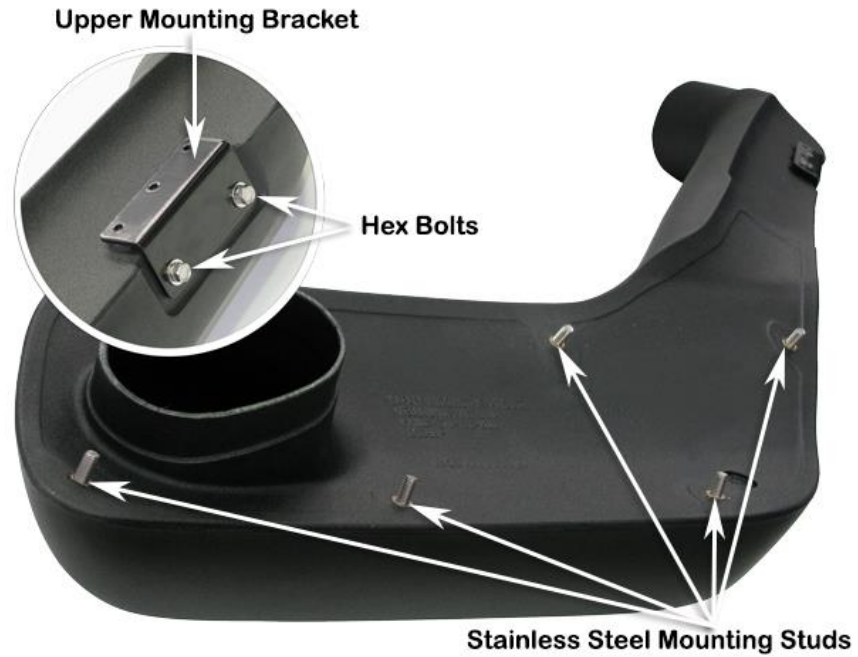

12

Remove the self-adhesive backing sheet from the foam body gasket (Item 20).

Align the foam body gasket (adhesive side down) to the back of the snorkel body and press down on the foam body gasket to adhere to the snorkel body (Item 1).



13

Place a strip of masking tape along the A-Pillar panel.

Carefully install the snorkel body (Item 1) to the guard panel.

With the snorkel body correctly positioned, mark the outline of the upper mounting bracket (Item 3) onto the masking tape.

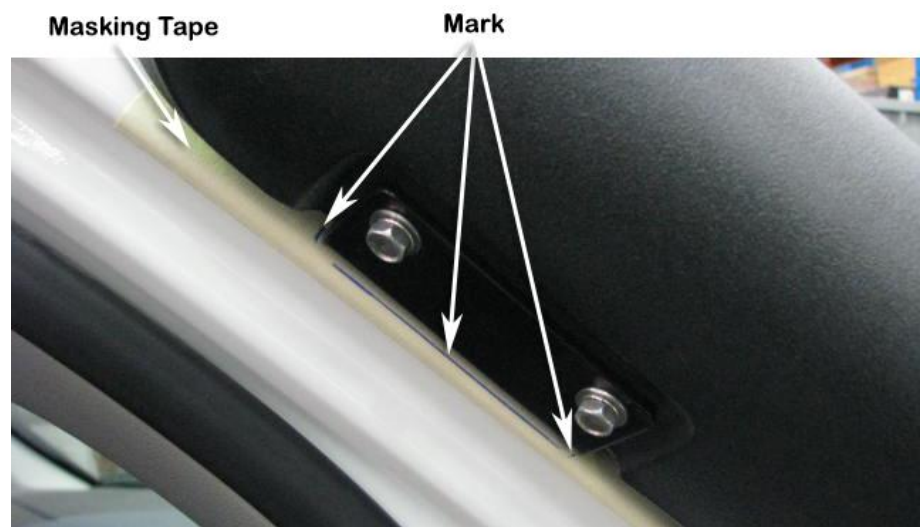

Remove the snorkel body (Item 1) from the vehicle, remove the upper mounting bracket (Item 3) from the snorkel body.

Position the upper mounting bracket onto the A-Pillar and align the bracket with the marked bracket outline. Mark the three mounting hole positions with a felt tip pen.

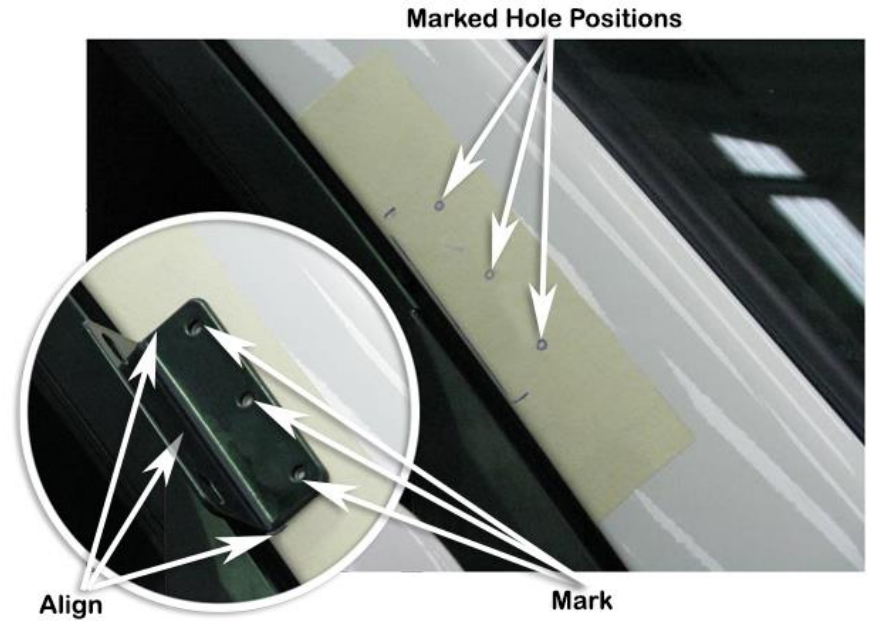

Drill a pilot hole for each of the three marked hole positions. Drill each hole position to 8mm diameter with a step drill or 8mm drill bit.

Deburr and paint holes.

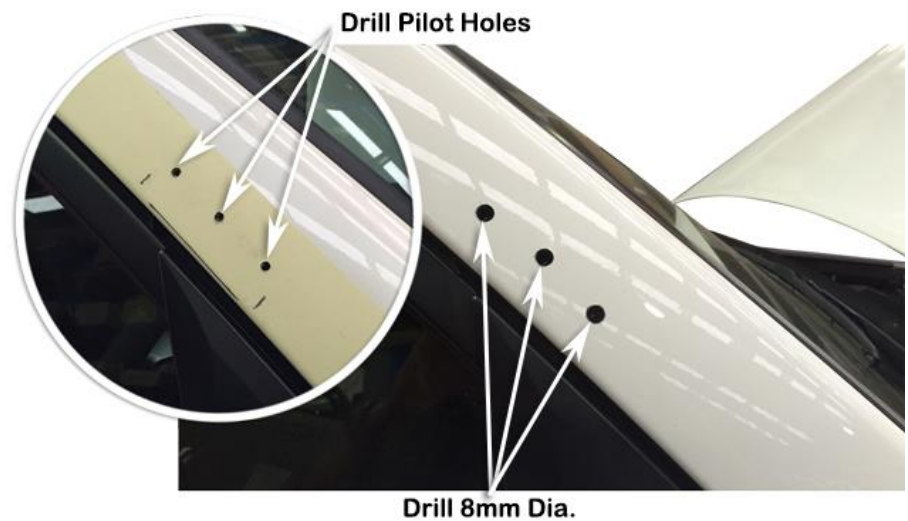

Install the plastic inserts (Item 6) into the 8mm diameter holes in the A-pillar.

Secure the upper mounting bracket (Item 3) to the A-pillar with three self-tapping screws (Item 5).

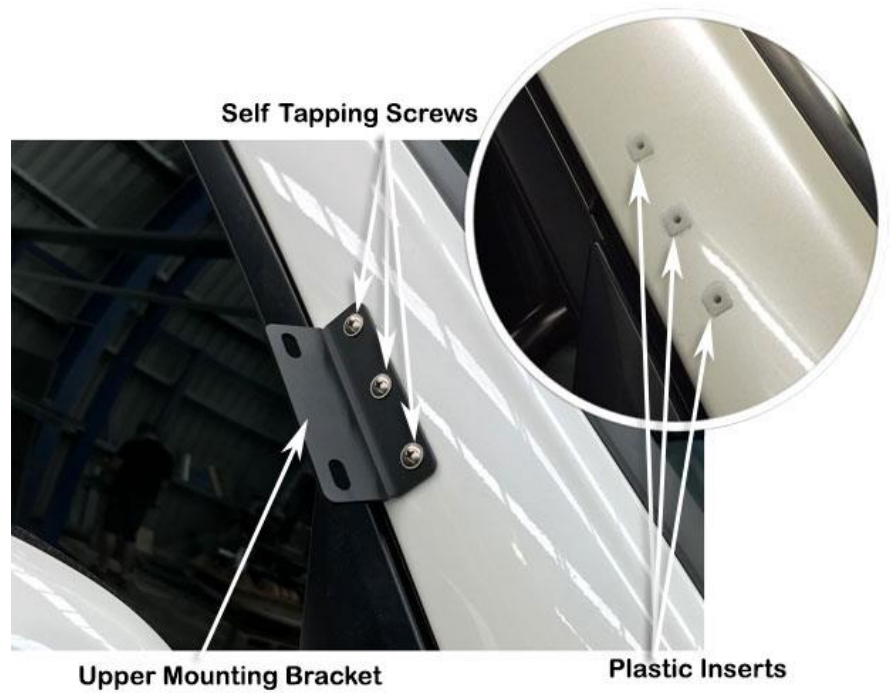

Install the A-pillar blank-off plate (item 17) and rubber gasket (Item 18) to the A-pillar, secure with the standard Toyota bolt assemblies removed in step 2.

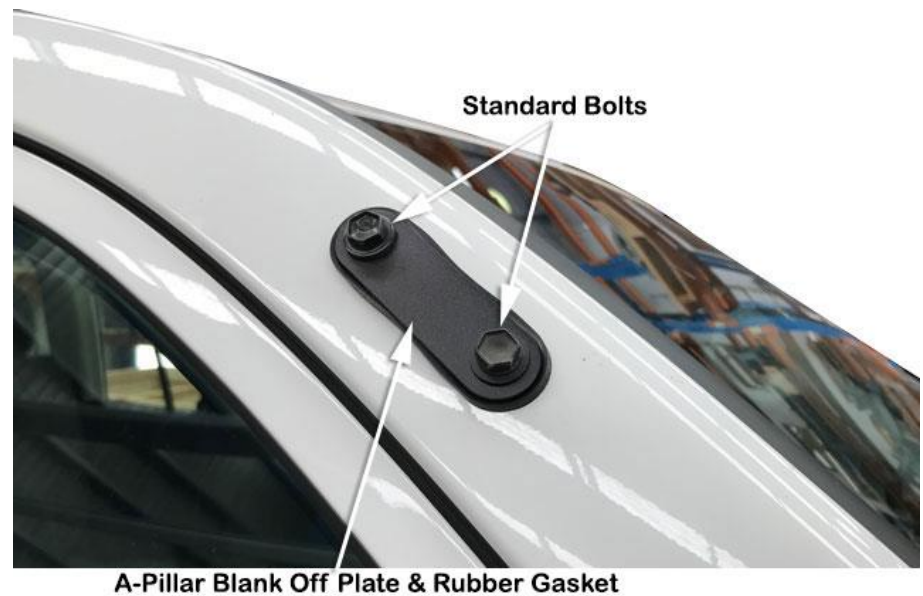

Remove and discard the foam sealing tape from the air cleaner inlet snout.

Depending on the year model of the vehicle either use a sharp knife to cut through the two plastic spot welds retaining the pre-spinner into the air cleaner inlet or use a small flat blade screwdriver to un-clip the pre-spinner from the air cleaner inlet.

Remove and discard the pre-spinner.



Remove the drain valve assembly from the air cleaner base.

The pre-spinner chamber must be completely removed from the air cleaner inlet, using the necessary tools carefully remove the chamber as shown.

Step 1; Using a die grinder with a cut-off disc remove as much of the internal tube as possible (46mm approximately), care must be taken when using the cut-off disc not to cut through the outer and inner walls of the air cleaner base.

Step 2; Using a die grinder with a suitable burr, carefully remove the end section of the pre-spinner chamber.

Step 3; Use a file to neatly remove the remaining material from the end of the chamber.

Step 4; Using compressed air thoroughly clean the air cleaner base.

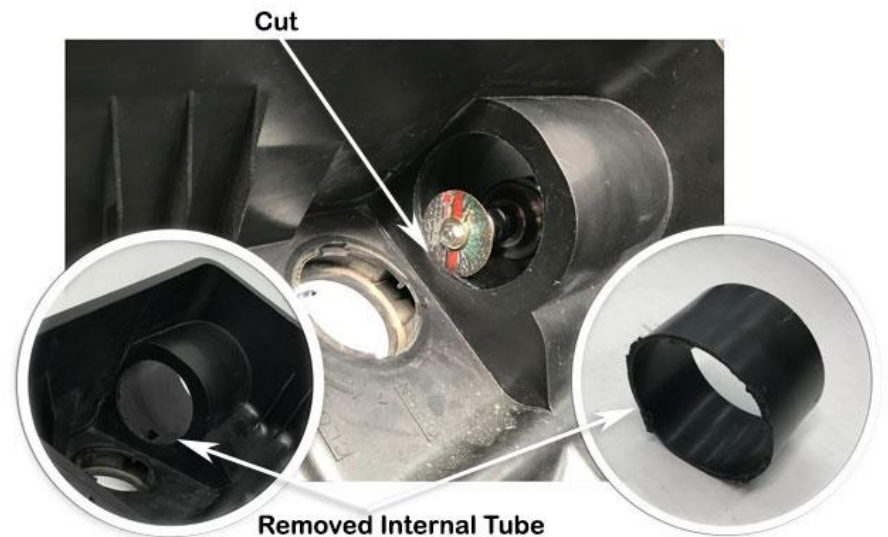

Apply Sikaflex adhesive sealant to the internal surface of the air cleaner inlet snout and install the air cleaner inlet support sleeve (item 16) flush with the end of the air cleaner inlet snout.



Using a scribe or paint pen, scribe or mark a line 18mm in from the end of the air cleaner inlet snout around the entire circumference as shown.

Refit the drain valve assembly into the air cleaner base.

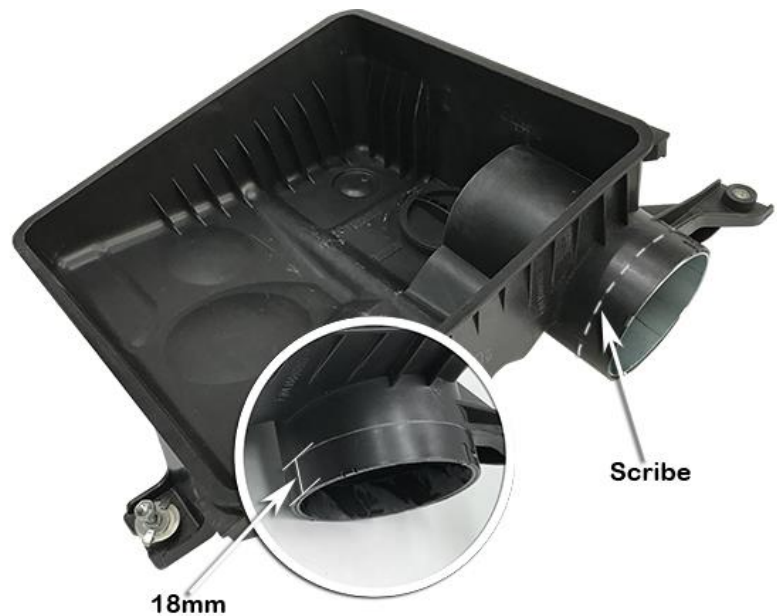

INSTALLER OPTION:

The air cleaner base contains a drain valve and a drain hole as shown. These can permit water to enter the air intake.

Safari advises that the drain valve and drain hole should be sealed to ensure a watertight installation.

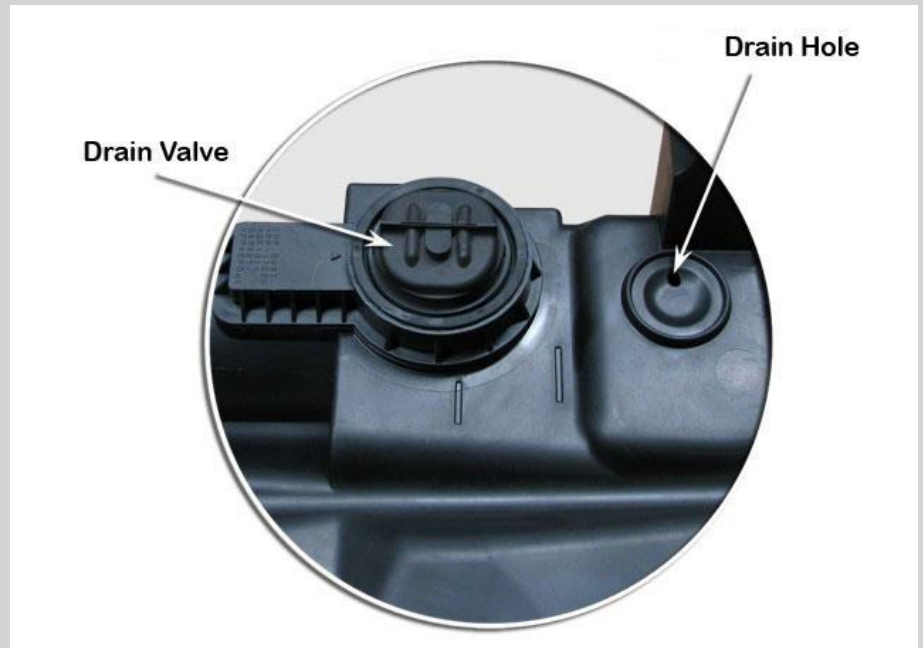

Install the air cleaner base into the vehicle. Fasten with the original mounting hardware.

Loosely install a 90/110mm hose clamp (item 12) over the air cleaner inlet snout.

Apply a small amount of lubricant to the round end of the air entry hose (item 11), install the hose through the hole in the inner guard panel and onto the air cleaner inlet snout, rotate and align the hose with the main hole in the guard panel.



Carefully shape the 120/140mm hose clamp (item 13) to the oval shape of the air entry hose (item 11).

Note: hose clamp orientation.

Loosely install the 120/140mm hose clamp (Item 13) onto the air entry hose (Item 11) orientated the hose clamp onto the air entry hose as shown.

Apply a small amount of lubricant to the inside of the air entry hose.

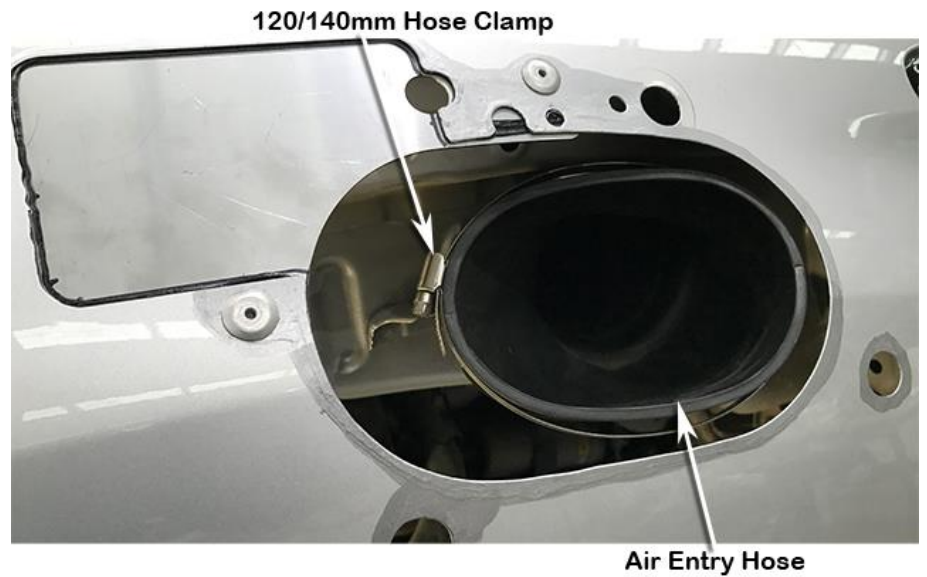

Carefully install the snorkel body (item 1) to the guard panel, guiding the snorkel body outlet snout into the air entry hose (item 11).

Align the snorkel body to the guard panel and upper mounting bracket, fasten the snorkel body to the guard panel with rubber washers (item 8), body washers (item 9) and nyloc nuts (item 10).

Fasten the snorkel body to the upper mounting bracket with hex bolts (item 4).

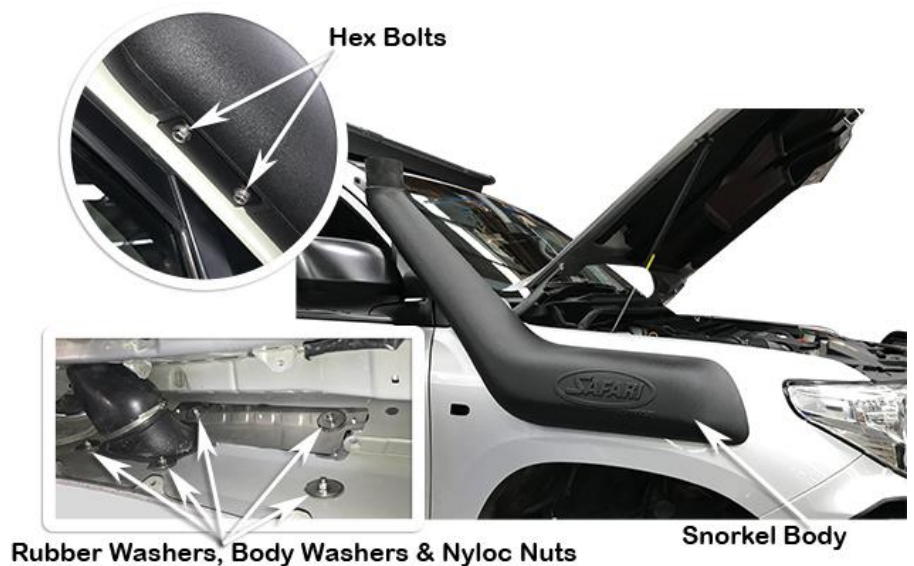

Align the air entry hose (item 11) for best fitment (*Ensure the air entry hose is correctly installed onto the air cleaner inlet snout*), position the 90/110mm hose clamp correctly onto the air entry hose and tighten, positioned and orientated the 120/140mm hose clamp correctly onto the air entry hose and tighten.

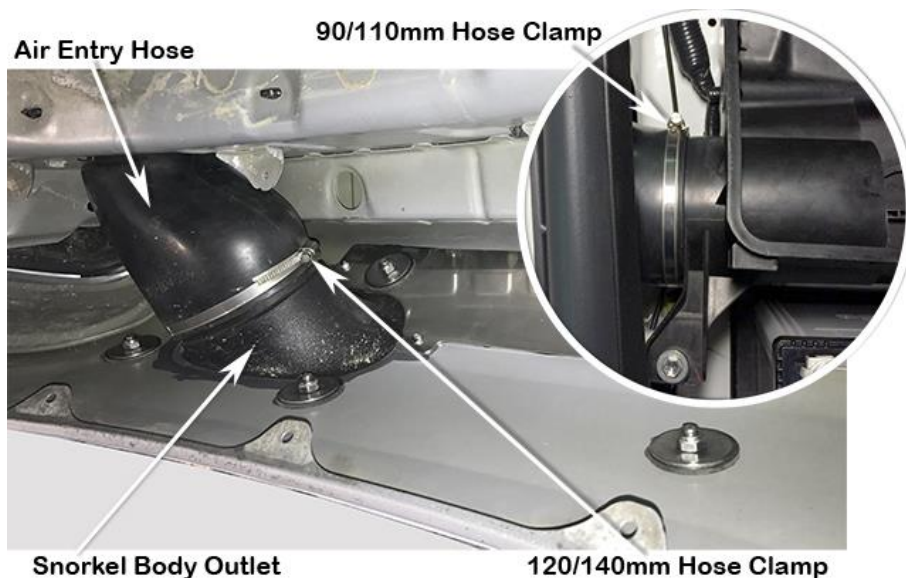

Loosely install the black hose clamp (Item 19) to the base of the air ram assembly (Item 2).

Install the air ram assembly onto the snorkel body (Item 1).

Align the air ram assembly and tighten the black hose clamp (Item 19).



Install the guard mounted indicator (if fitted to vehicle), inner guard liner, mud flap, air filter element, air cleaner lid, reconnect sensor wiring and any other items that may have been removed in accordance with the factory service manual.

N.B: It is the installer's responsibility to ensure that all connections are water tight.